

PLANTA - Medidas interiores

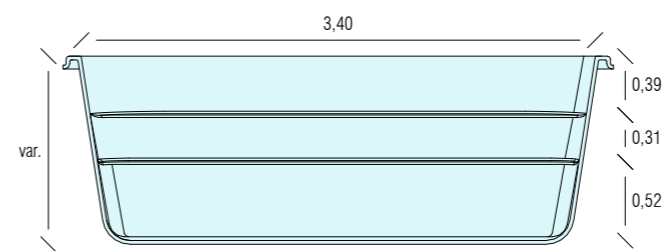

CORTE A-A

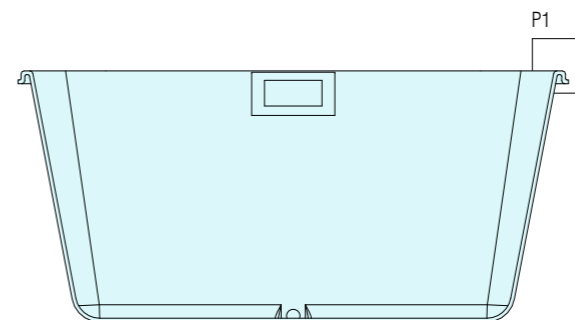

CORTE B-B

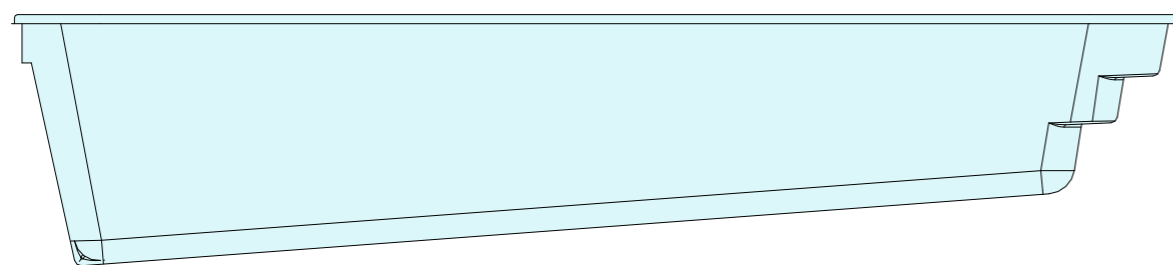

ALÇADO LATERAL ESQUERDO

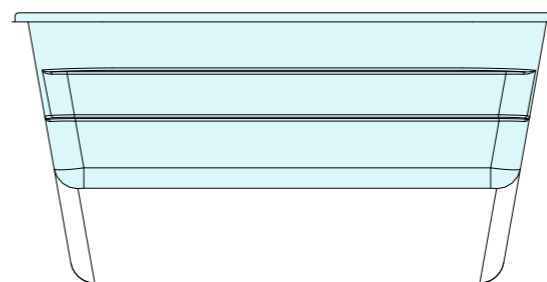

ALÇADO FRONTAL

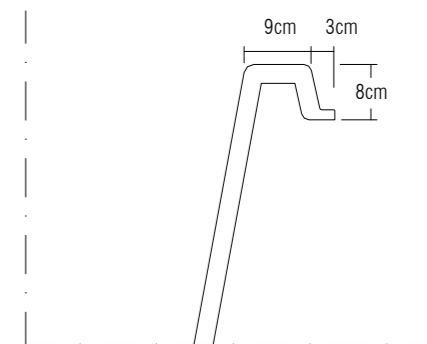

PORMENOR P1 - ESC 1:10

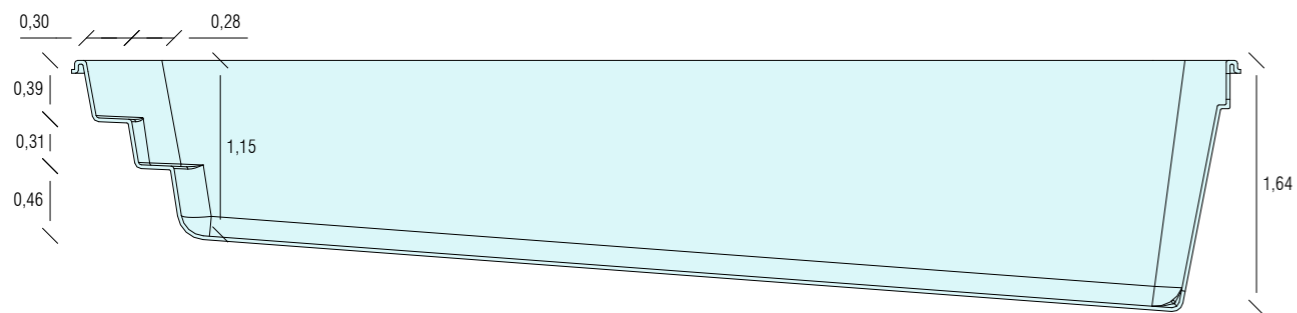

CORTE C-C

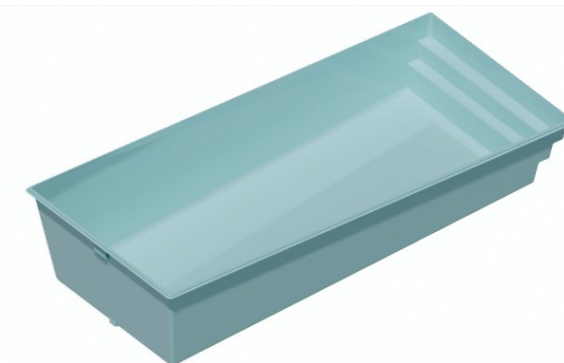
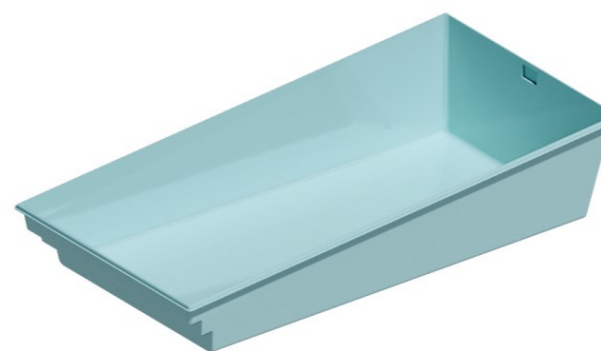

OCEAN 7

DIMENSÕES:

Interior - 7.53x 3.44
Exterior - 7.73x 3.64m

Prof: 1.15m/ 1.64

prodoFibra piscinas

Cotas de Escavação
unidade: metro

A	B	C	D
4.14	8.23	1.20	1.81

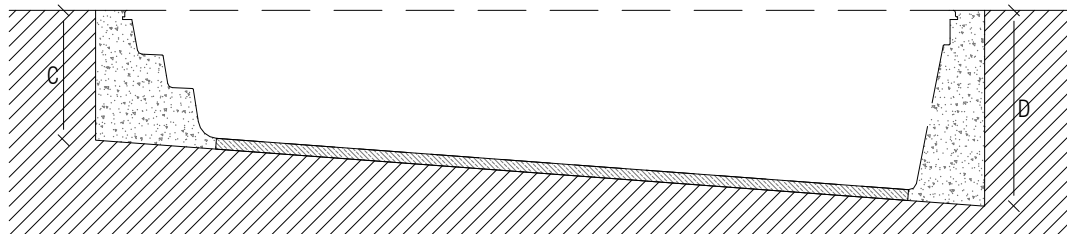
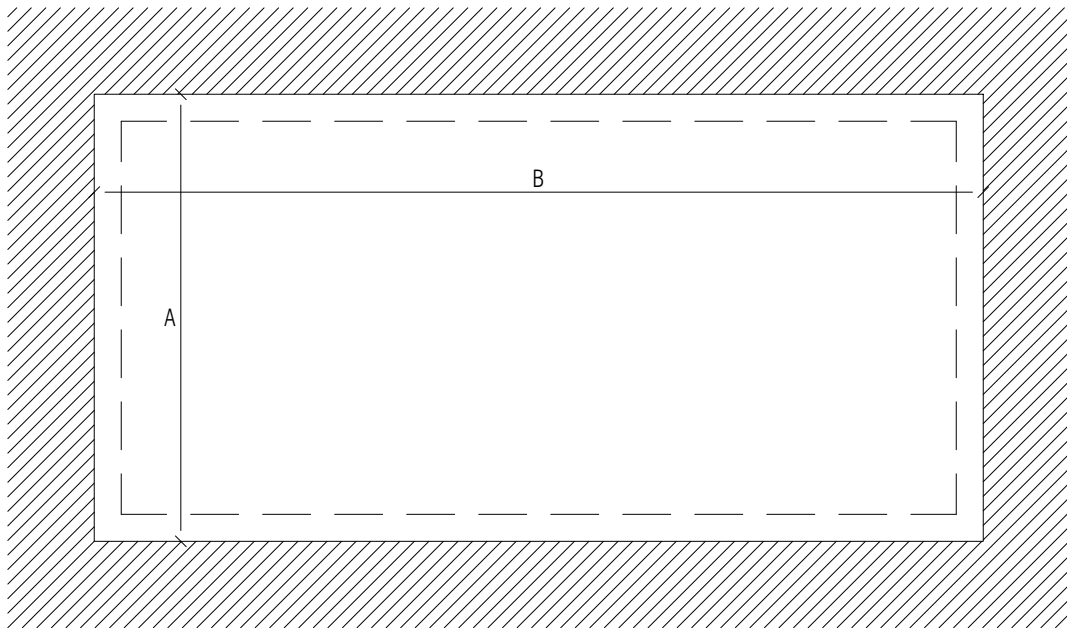

Cotas de Fundação
unidade: metro

A	B	C	D	E	F	G	H
3.08m	6.41	0.71	1.12	1.19m	1.66	0.10m	0.67m

