

PLANTA

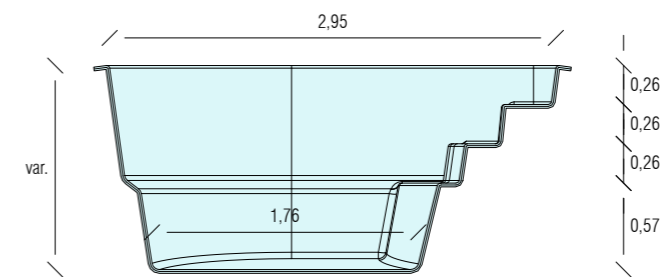

CORTE A-A

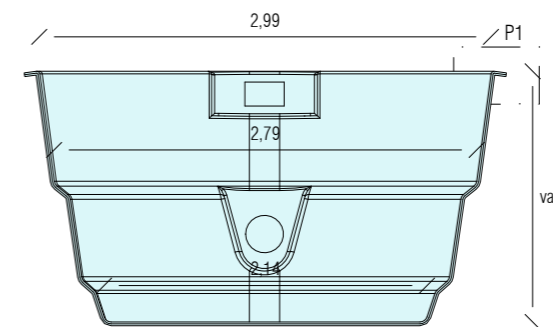

CORTE B-B

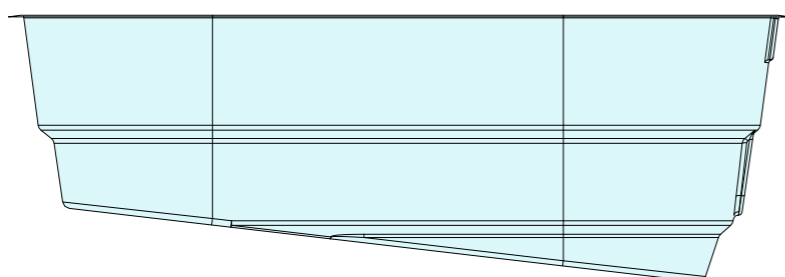

ALÇADO LATERAL DIREITO

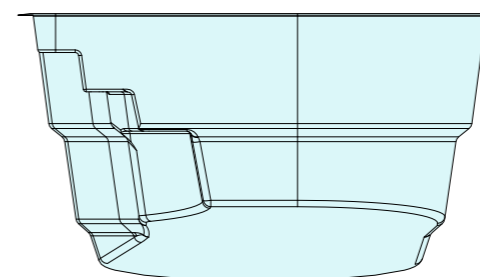

ALÇADO FRONTAL

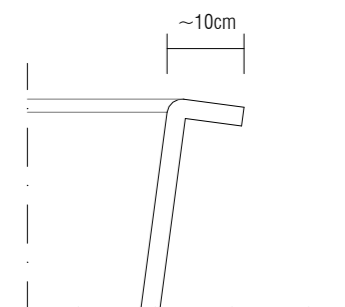

PORMENOR P1 - ESC 1:10

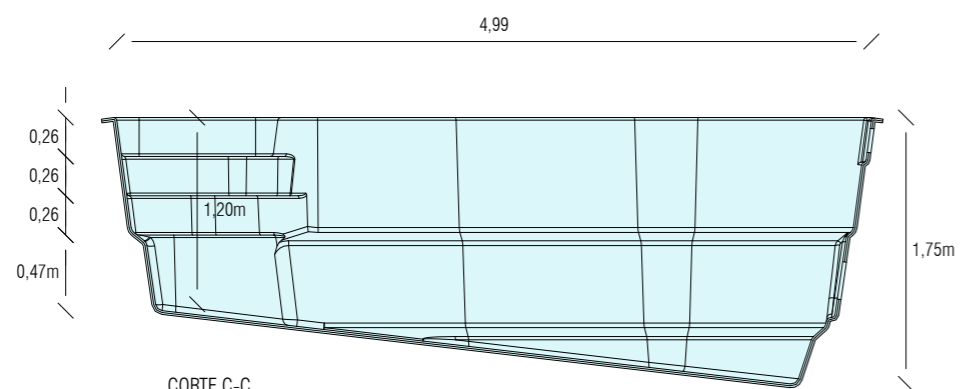

CORTE C-C



<b>RELAX 5</b>	
DIMENSÕES:	
Interior - 4.99m x 2.98m	Prof: 1.20m/ 1.75m
Exterior - 5.17m x 3.20m	



Cotas de Escavação  
unidade: metro

A	B	C	D
3.70	5.67	1.33	1.99

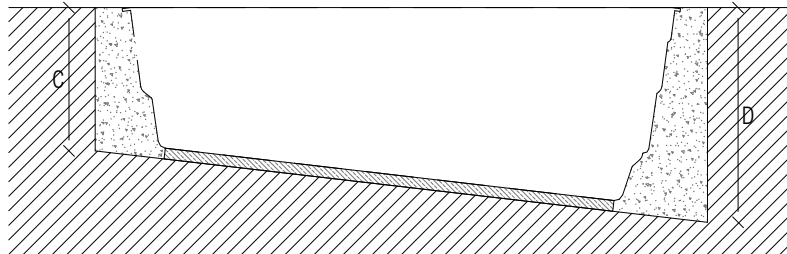
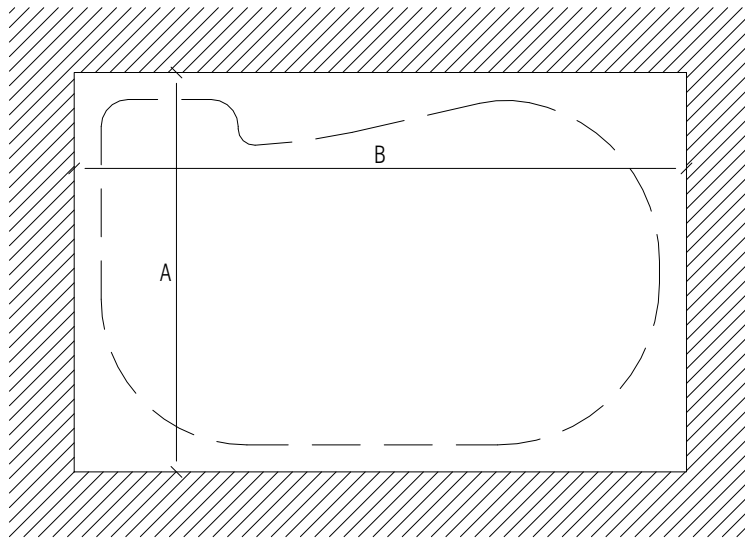

Cotas de Fundação  
unidade: metro

A	B	C	D	E	F	G	H
2.25	4.47	0.81	0.49	1.21	1.75	0.10m	0.73

